

Specifications

Drawing No.	USY1P-H1-16609-00	1 / 10
Issued Date.	Jun,14,2016	

Messrs: Digi-Key

Note: In case of specification change, KYOCERA Part Number also will be changed.

Product Name	Crystal Units with Thermistor
Product Model	CT2016DB
Frequency	38400kHz
Customer Part Number	-
Customer Specification Number	-
KYOCERA Part Number	CT2016DB38400C0FLHA2
Remarks Pb-Free, RoHS Compliant, MSL 1	

Customer Acceptance

Accept Signature	Approved Date	
	Department	
	Person in charge	

Seller

KYOCERA Crystal Device Corporation
 (Sales Division)
 6 Takeda Tobadono-cho, Fushimi-ku, Kyoto
 612-8501 Japan
 TEL. No. 075-604-3421
 FAX. No. 075-604-3469

Manufacturer

KYOCERA Crystal Device Corporation
 (Marketing & Sales Engineering Division)
 5850, Higashine-Koh, Higashine-Shi, Yamagata
 999-3701 Japan
 TEL. No. 0237-43-5611
 FAX. No. 0237-43-5615

Design Department	Quality Assurance	Approved by	Checked by	Issued by
KYOCERA Crystal Device Corporation Crystal Unit Application Engineering Section Crystal Units Division	S.Itoh	T.Soda	A.Muraoka	Y.Nozaki

Revision History

Rev.No.	Description of revise	Date	Approved by	Checked by	Issued by
00	First Edition	Jun,14,2016	T.Soda	A.Muraoka	Y.Nozaki

1. APPLICATION

This specification sheet is applied to Crystal Units with Thermistor “CT2016DB”

2. KYOCERA PART NUMBER

CT2016DB38400C0FLHA2

3. RATINGS

Items	SYMB.	Rating	Unit	Remarks
Operating Temperature range	Topr	-30~+105	°C	
Storage Temperature range	Tstg	-40~+105	°C	

4. CHARACTERISTICS

4-1 ELECTRICAL CHARACTERISTICS

Items	Electrical Specification					Test Condition	Remarks
	SYMB.	Min	Typ.	Max	Unit		
Mode of Vibration		Fundamental					
Nominal Frequency	F0		38.4		MHz		
Nominal Temperature	T _{NOM}		29		°C		
Load Capacitance	CL		7.0		pF		
Frequency Tolerance	dF	-10.0		+10.0	ppm	+25±3°C	
Frequency Temperature Characteristics	dF _T	-12.0		+12.0		-30~+85°C	
Equivalent Series Resistance	ESR			80	Ω		
Drive Level	Pd	0.01	0.05	0.1	mW		
Insulation Resistance	IR	500			MΩ	100V(DC)	

4-2 ELECTRICAL CHARACTERISTICS (Thermistor)

Items	Electrical Specification					Remarks
	SYMB.	Min	Typ.	Max	Unit	
Resistance			100		kΩ	25°C
B-Constant			4250		K	25°C - 50°C
Tolerance		-1.0		1.0	%	

5. APPEARANCES, PHYSICAL DIMENSION
OUTLINE DIMENSION (not to scale)

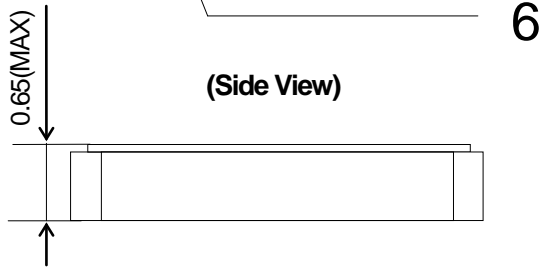
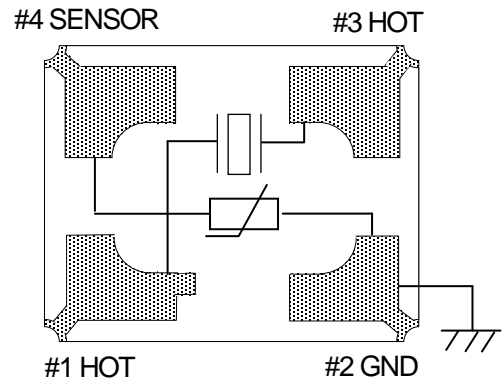
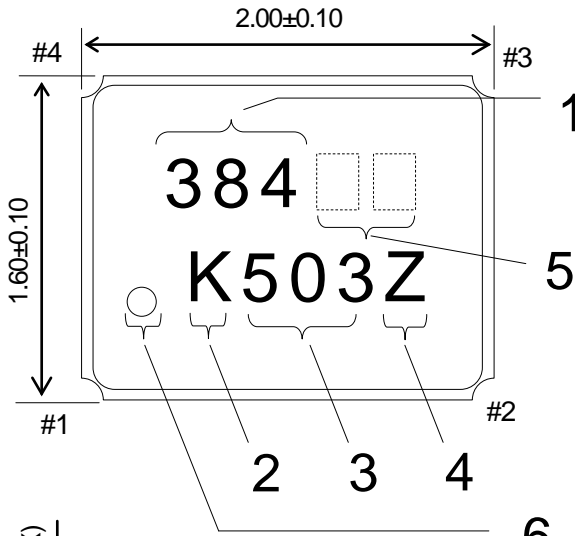

PIN No.	PIN Layout
#1	HOT
#2	GND
#3	HOT
#4	SENSOR

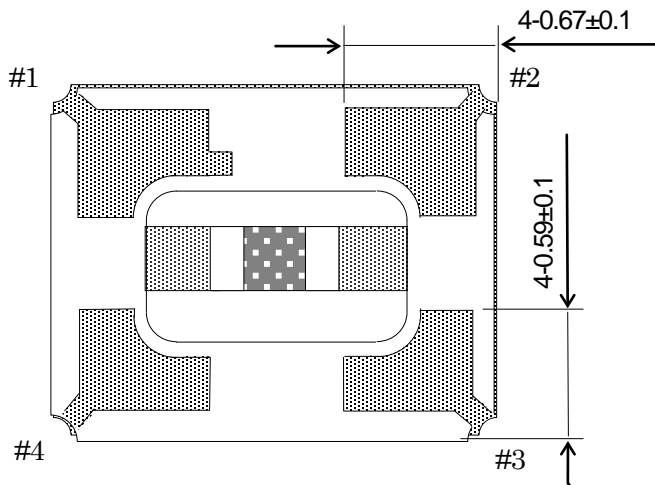

UNIT: mm

MARKING

- | | | |
|---|------------------------|---|
| 1 | Nominal Frequency | First 3digits of the frequency are indicated. |
| 2 | Identification | [K] is to indicate 1Pin direction |
| 3 | Date Code | Last 1 Digit of YEAR and WEEK
(Ex) 2015,Jan,15 → 503 |
| 4 | Manufacturing Location | Y →Japan(Yamagata) Z →Japan(Shiga Yohkaichi) |
| 5 | Option Code | Alphabet & Number 2digits or blank.(For T-Sensor) |
| 6 | 1Pin mark | |

6. RECOMMENDED LAND PATTERN (not to scale)

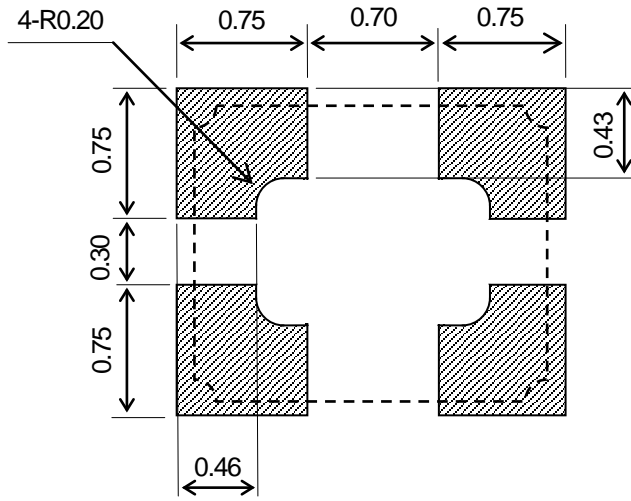

UNIT : mm

7.TAPING&REEL

7-1.Dimensions

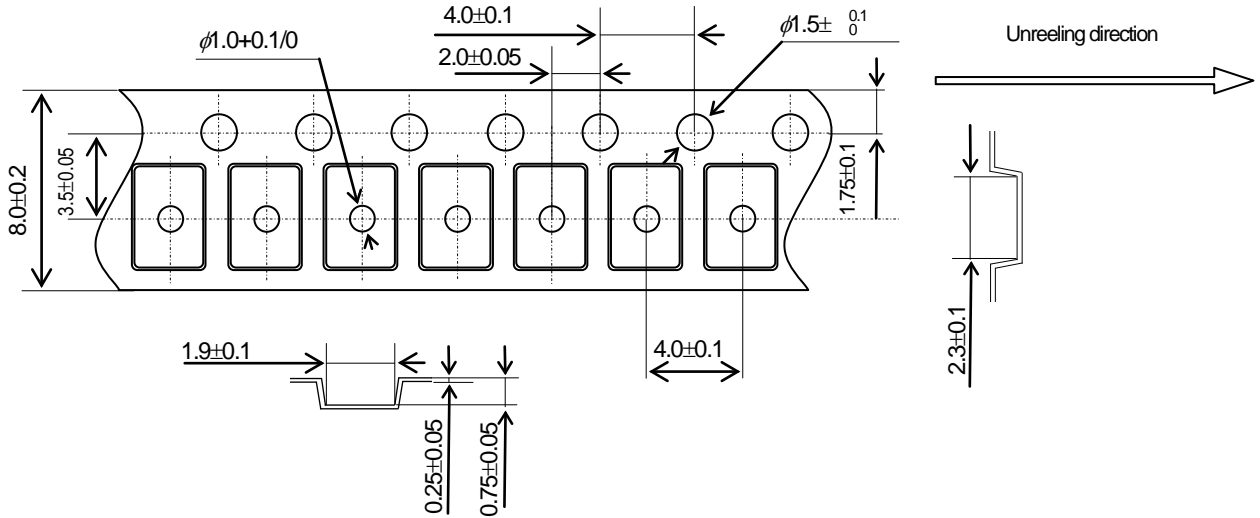

7-2.Leader and trailer tape

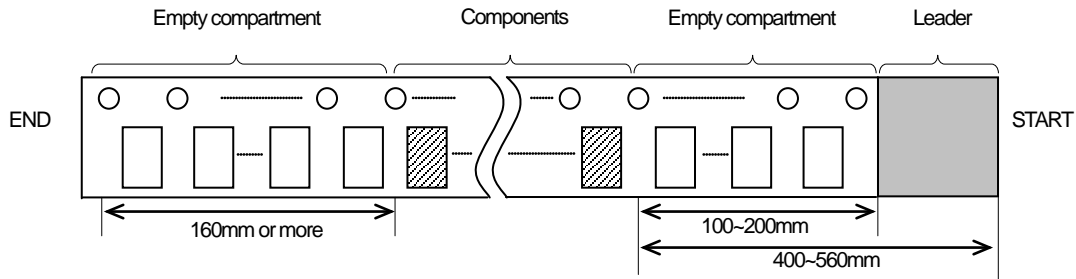

7-3.Direction (Orientation shall be checked from the top cover tape side)

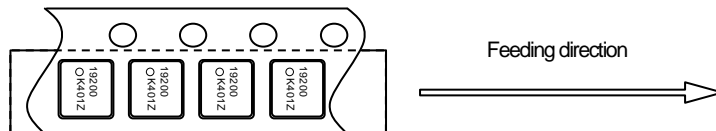

7-4.Specification

1. Material of the carrier tape is either polystyrene or A-PET (ESD).
2. Material of the cover tape is polyester (ESD).
3. The seal tape shall not cover the sprocket holes and not protrude from the carrier tape.
4. Tensile strength of carrier tape: 10N or more.
5. The R of the corner of each cavity is 0.2RMAX.
6. The alignment between centers of the cavity and sprocket hole shall be 0.05mm or less.
7. The orientation shall be checked from the top cover tape side as shown in 7-3.
8. Peeling force of cover tape: 0.1 to 1.0N.
9. The component will fall out naturally when cover tape is removed and set upside down.
10. Surface resistivity → Carrier tape: $\geq 1 \times 10^7$, Cover tape: $> 1 \times 10^{11}$

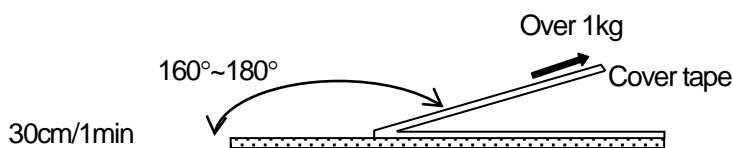

Reel specifications

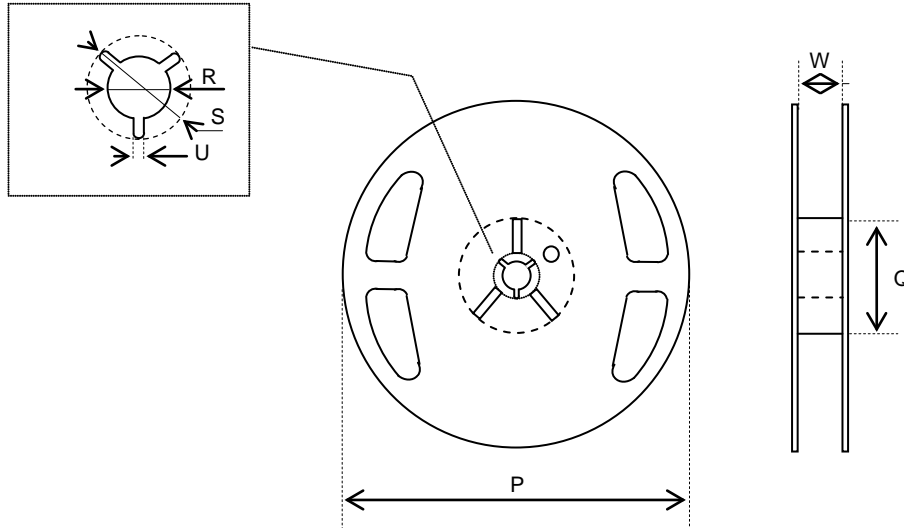

φ180 Reel (3,000 pcs)

Symbol	P	Q	R
Dimension	φ180 +0/-3	φ60 +1/-0	φ13±0.2
Symbol	S	U	W
Dimension	φ21±0.8	2.0±0.5	9±1

(Unit: mm)

φ330 Reel(12000pcs)

Symbol	P	Q	R
Dimension	φ330±2.0	φ100±1.0	φ13±0.2
Symbol	S	U	W
Dimension	φ21±0.8	2.0±0.5	9.4±0.5

(Unit : mm)

8. Cautions for use

(1) Soldering upon mounting

There is a possibility to influence product characteristics when Solder paste or conductive glue comes in contact with product lid or surface.

(2) When using mounting machine

Please minimize the shock when using mounting machine to avoid any excess stress to the product.

(3) Conformity of a circuit

We strongly recommend to make sure that Negative resistance (Gain) of IC is designed to be 3 times the ESR (Equivalent Series Resistance) of crystal unit.

9. Storage conditions

Please store product in below conditions, and use within 6 months.

Temperature +18 to +30°C, and Humidity of 20 to 70 % in the packaging condition.

10. Manufacturing location

Kyocera Crystal Device Corporation Yamagata Plant

Kyocera Crystal Device Corporation Shiga Yohkaichi Plant

Kyocera Crystal Device (Thailand) Co., Ltd

11. Quality Assurance

To be guaranteed by Kyocera Crystal Device Quality Assurance Division

12. Quality guarantee

In case when Kyocera Crystal Device Corporation rooted failure occurred within 1year after its delivery, substitute product will be arranged based on discussion. Quality guarantee of product after 1year of its delivery is waived.

13. Others

In case of any questions or opinions regarding the Specification, please have it in written manner within 45 days after issued date.